

Write your name here

Surname

Other names

**Pearson Edexcel
International GCSE**

Centre Number

--	--	--	--	--

Candidate Number

--	--	--	--

Mathematics A

Paper 4HR



Higher Tier

Thursday 7 June 2018 – Morning
Time: 2 hours

Paper Reference

4MA0/4HR

You must have:

Ruler graduated in centimetres and millimetres, protractor, compasses, pen, HB pencil, eraser, calculator. Tracing paper may be used.

Total Marks

Instructions

- Use **black** ink or ball-point pen.
- **Fill in the boxes** at the top of this page with your name, centre number and candidate number.
- Answer **all** questions.
- Without sufficient working, correct answers may be awarded no marks.
- Answer the questions in the spaces provided
– *there may be more space than you need.*
- **Calculators may be used.**
- You must **NOT** write anything on the formulae page.
Anything you write on the formulae page will gain NO credit.

Information

- The total mark for this paper is 100.
- The marks for **each** question are shown in brackets
– *use this as a guide as to how much time to spend on each question.*

Advice

- Read each question carefully before you start to answer it.
- Check your answers if you have time at the end.

Turn over ►

P53383A

©2018 Pearson Education Ltd.

1/1/1



Pearson

**International GCSE MATHEMATICS
FORMULAE SHEET – HIGHER TIER**

Pythagoras' Theorem

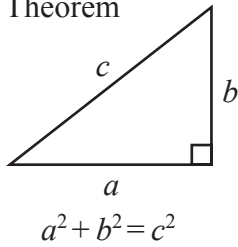

Volume of cone = $\frac{1}{3} \pi r^2 h$

Curved surface area of cone = $\pi r l$

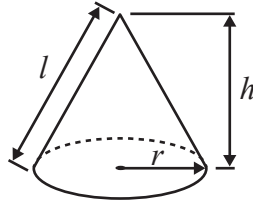

Volume of sphere = $\frac{4}{3} \pi r^3$

Surface area of sphere = $4 \pi r^2$

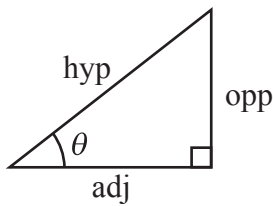
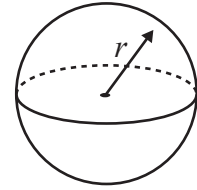

adj = hyp \times cos θ
opp = hyp \times sin θ
opp = adj \times tan θ

or $\sin \theta = \frac{\text{opp}}{\text{hyp}}$

$\cos \theta = \frac{\text{adj}}{\text{hyp}}$

$\tan \theta = \frac{\text{opp}}{\text{adj}}$

In any triangle ABC

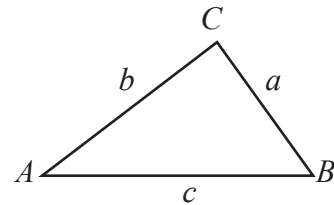

Sine rule: $\frac{a}{\sin A} = \frac{b}{\sin B} = \frac{c}{\sin C}$

Cosine rule: $a^2 = b^2 + c^2 - 2bc \cos A$

Area of triangle = $\frac{1}{2} ab \sin C$

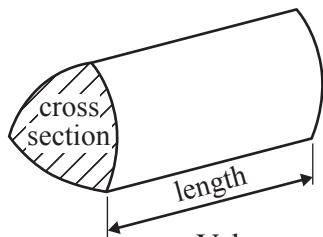

Volume of prism = area of cross section \times length

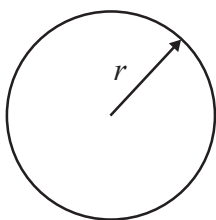

Circumference of circle = $2 \pi r$

Area of circle = πr^2

Area of a trapezium = $\frac{1}{2}(a + b)h$

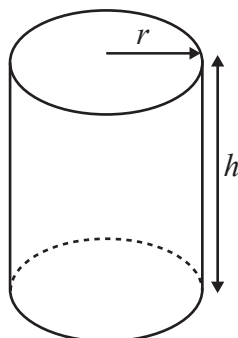
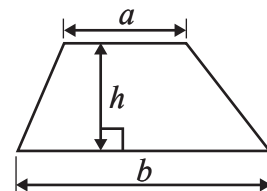

Volume of cylinder = $\pi r^2 h$

Curved surface area of cylinder = $2 \pi r h$

The Quadratic Equation

The solutions of $ax^2 + bx + c = 0$, where $a \neq 0$, are given by

$$x = \frac{-b \pm \sqrt{b^2 - 4ac}}{2a}$$

DO NOT WRITE IN THIS AREA

DO NOT WRITE IN THIS AREA

DO NOT WRITE IN THIS AREA



DO NOT WRITE IN THIS AREA

DO NOT WRITE IN THIS AREA

DO NOT WRITE IN THIS AREA

Answer ALL TWENTY FIVE questions.

Write your answers in the spaces provided.

You must write down all the stages in your working.

- 1** Three numbers have
- a mean of 17
 - a median of 20
 - a range of 27

Find the three numbers.

..... , ,

(Total for Question 1 is 3 marks)



2

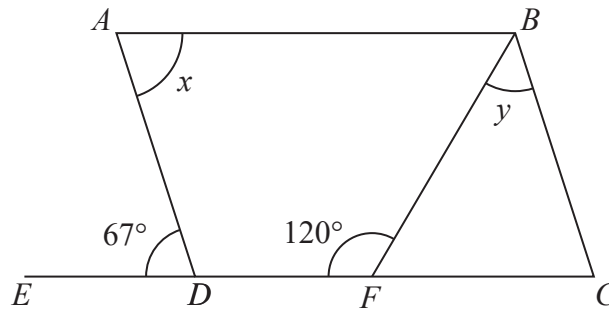

Diagram **NOT** accurately drawn

$ABCD$ is a parallelogram.
 $EDFC$ is a straight line.

(a) (i) Write down the size of angle x .

..... °

(ii) Give a reason for your answer.

(2)

(b) Work out the size of angle y .

..... °

(2)

(Total for Question 2 is 4 marks)

DO NOT WRITE IN THIS AREA

DO NOT WRITE IN THIS AREA

DO NOT WRITE IN THIS AREA



DO NOT WRITE IN THIS AREA

DO NOT WRITE IN THIS AREA

DO NOT WRITE IN THIS AREA

3 The table gives information about the number of trees in each of 20 gardens.

Number of trees	Frequency
0	2
1	7
2	3
3	4
4	3
5	1

(a) Work out the total number of trees in these gardens.

.....
(2)

(b) Find the median number of trees in these gardens.

.....
(1)

(Total for Question 3 is 3 marks)

4 Charlotte earns £8.50 per hour.
She gets a pay rise of 6%

Work out how much Charlotte earns per hour after her pay rise.

£.....

(Total for Question 4 is 3 marks)



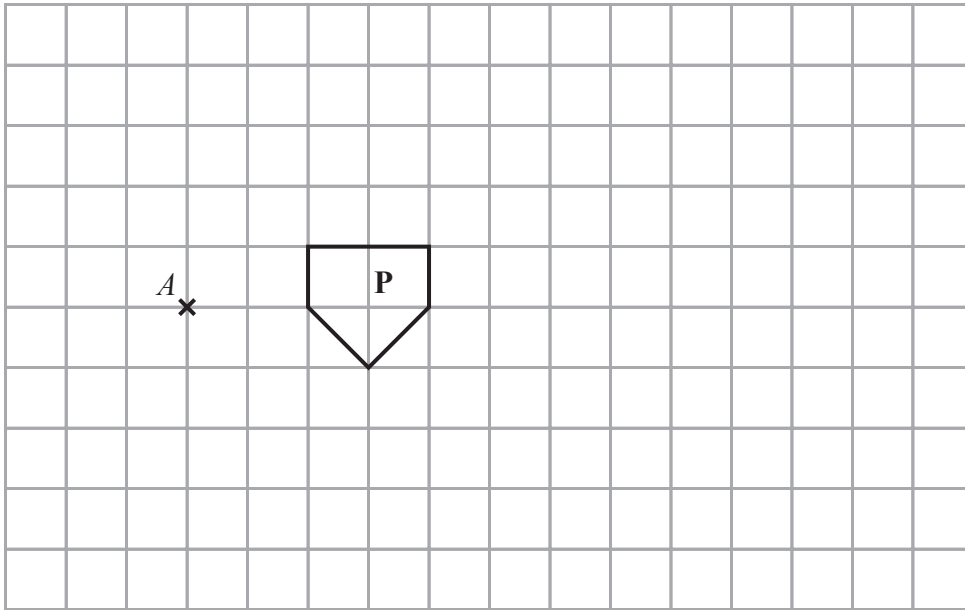

(a) On the grid, enlarge shape **P** with scale factor 3 and centre *A*.

(2)

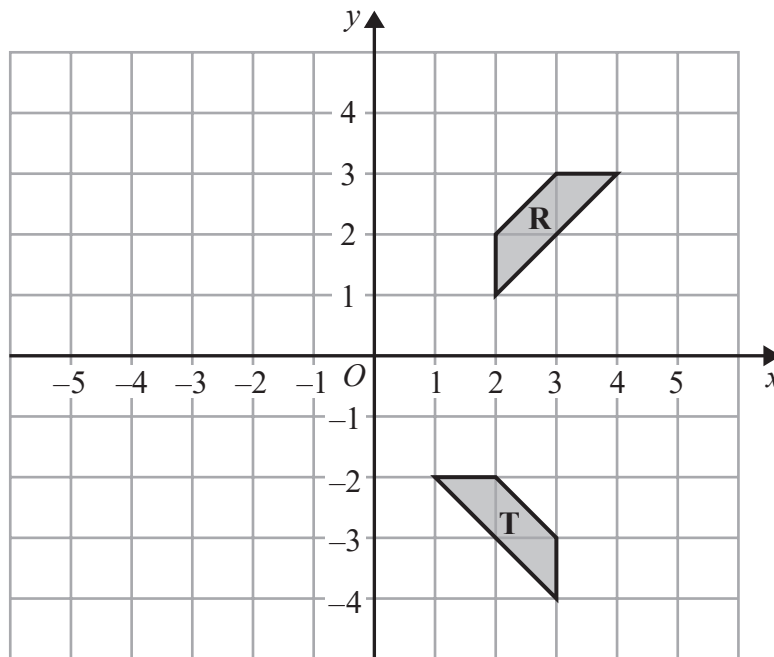

(b) Describe fully the single transformation that maps shape **R** onto shape **T**.

(3)

(Total for Question 5 is 5 marks)



DO NOT WRITE IN THIS AREA

DO NOT WRITE IN THIS AREA

DO NOT WRITE IN THIS AREA

6 A plane flew from Sydney to Wellington.

The distance the plane flew was 2240 km.
The average speed of the plane was 805 km/h.

Work out the time taken by the plane to fly from Sydney to Wellington.
Give your answer in hours and minutes, correct to the nearest minute.

..... hours minutes

(Total for Question 6 is 3 marks)

7 Solve the simultaneous equations

$$y = 4x$$
$$7x - y = -13.5$$

Show clear algebraic working.

$x =$

$y =$

(Total for Question 7 is 3 marks)



P 5 3 3 8 3 A 0 7 2 4

8 A , B and C are three cities.

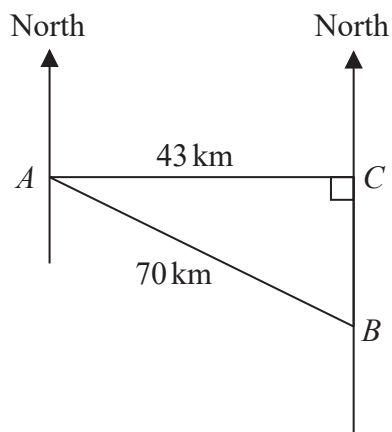

Diagram **NOT** accurately drawn

City C is due east of city A and due north of city B .
City A is 43 km from city C and 70 km from city B .

Work out the bearing of city B from city A .
Give your answer correct to the nearest degree.

.....
(Total for Question 8 is 4 marks)

DO NOT WRITE IN THIS AREA

DO NOT WRITE IN THIS AREA

DO NOT WRITE IN THIS AREA



9 (a) Simplify $(3a^2b^4)^3$

.....
(2)

(b) Expand and simplify $4(g - 2h) + 5(2g - 3h)$

.....
(2)

(c) Expand and simplify $(y - 7)(y + 5)$

.....
(2)

(d) Solve the inequalities $-5 \leq 2p + 3 < 13$

.....
(3)

(Total for Question 9 is 9 marks)



10 (a) Write 280 as a product of its prime factors.
Show your working clearly.

.....
(3)

(b) Find the Highest Common Factor (HCF) of 280 and 630

.....
(2)

(Total for Question 10 is 5 marks)

DO NOT WRITE IN THIS AREA

DO NOT WRITE IN THIS AREA

DO NOT WRITE IN THIS AREA



DO NOT WRITE IN THIS AREA

DO NOT WRITE IN THIS AREA

DO NOT WRITE IN THIS AREA

11 A group of 15 businessmen were asked to give the number of different countries they had each visited on business.

Here are the results.

0 1 3 3 4 6 7 8 8 9 10 10 11 12 14

Work out the interquartile range of the number of countries visited.

.....
(Total for Question 11 is 2 marks)

12 Solve $\frac{5x - 2}{3} + \frac{3 - 5x}{4} = 2$

Show clear algebraic working.

$x =$

(Total for Question 12 is 4 marks)



13 (a) Write 0.000 037 in standard form.

.....
(1)

(b) Write 234×10^7 in standard form.

.....
(1)

The population of China is 1.4×10^9

The population of Morocco is 3.5×10^7

The population of China is k times the population of Morocco.

(c) Work out the value of k .

.....
(2)

(Total for Question 13 is 4 marks)

DO NOT WRITE IN THIS AREA

DO NOT WRITE IN THIS AREA

DO NOT WRITE IN THIS AREA



DO NOT WRITE IN THIS AREA

DO NOT WRITE IN THIS AREA

DO NOT WRITE IN THIS AREA

14 Genevieve has two bags of marbles, bag A and bag B.

In bag A there are only 3 red marbles and 4 green marbles.

In bag B there are only 4 red marbles and 5 yellow marbles.

Genevieve takes at random one marble from each bag.

(a) Complete the probability tree diagram.

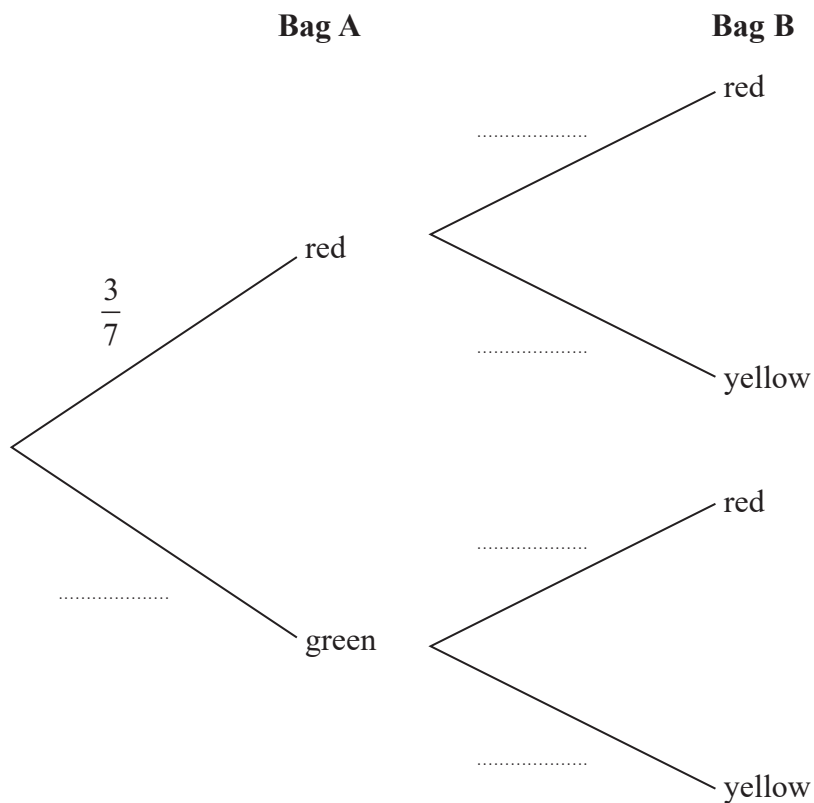

(2)

(b) Work out the probability that Genevieve takes two red marbles.

(2)

(Total for Question 14 is 4 marks)



P 5 3 3 8 3 A 0 1 3 2 4

15 (a) Complete the table of values for $y = x^3 - 2x + 3$

x	-3	-2	-1	0	1	2	3
y		-1	4	3		7	

(2)

(b) On the grid, draw the graph of $y = x^3 - 2x + 3$ for values of x from -3 to 3

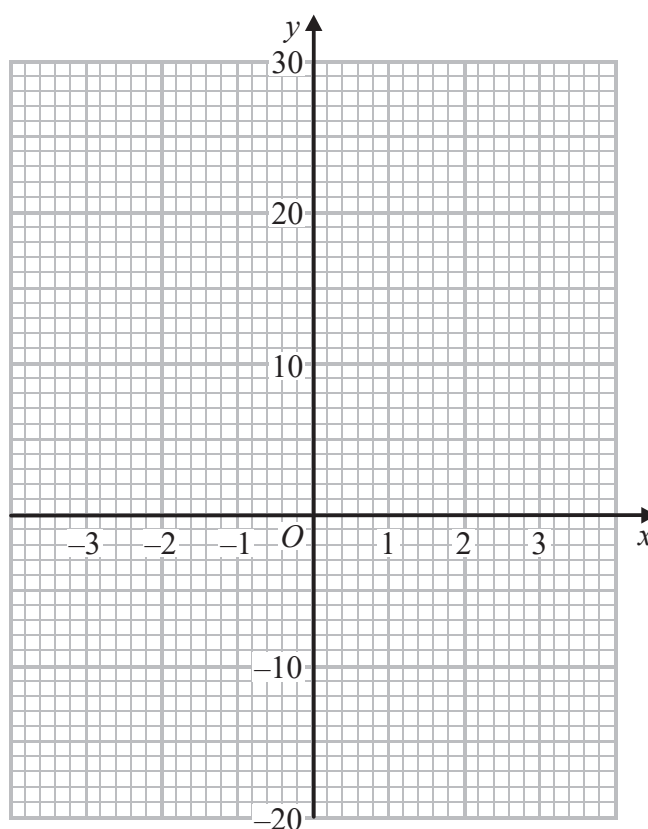

(2)

(c) By drawing a suitable straight line on the grid, find estimates for the solutions of the equation $x^3 - 5x + 1 = 0$

Give your solutions correct to 1 decimal place.

(3)

(Total for Question 15 is 7 marks)



DO NOT WRITE IN THIS AREA

DO NOT WRITE IN THIS AREA

DO NOT WRITE IN THIS AREA

16 Make w the subject of the formula $p = \sqrt{\frac{w+4}{w-2}}$

.....
(Total for Question 16 is 4 marks)



Diagram NOT accurately drawn

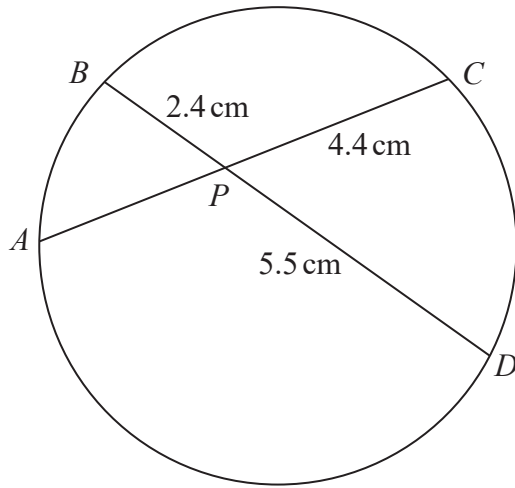

A, B, C and D are points on a circle.
 APC and BPD are straight lines.

$PB = 2.4$ cm, $PD = 5.5$ cm and $PC = 4.4$ cm.

Work out the length of PA .

.....cm

(Total for Question 17 is 2 marks)

DO NOT WRITE IN THIS AREA

DO NOT WRITE IN THIS AREA

DO NOT WRITE IN THIS AREA



DO NOT WRITE IN THIS AREA

DO NOT WRITE IN THIS AREA

DO NOT WRITE IN THIS AREA

18 The incomplete histogram and table give information about the lengths of time, in minutes, that some people spent at an airport.

Time (t minutes)	Frequency
$0 < t \leq 50$	10
$50 < t \leq 80$	15
$80 < t \leq 120$	
$120 < t \leq 180$	
$180 < t \leq 240$	12
$240 < t \leq 320$	8

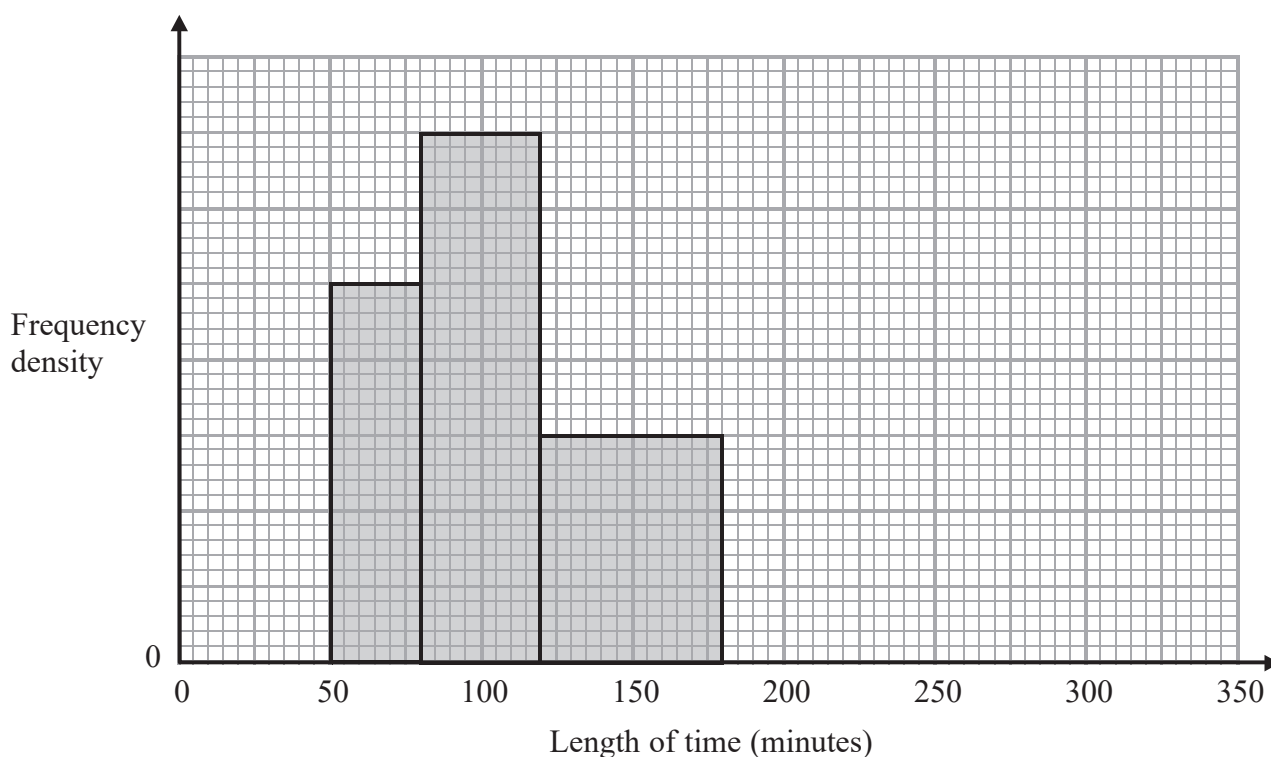

(a) Use the histogram to complete the table.

(2)

(b) Use the table to complete the histogram.

(2)

(Total for Question 18 is 4 marks)

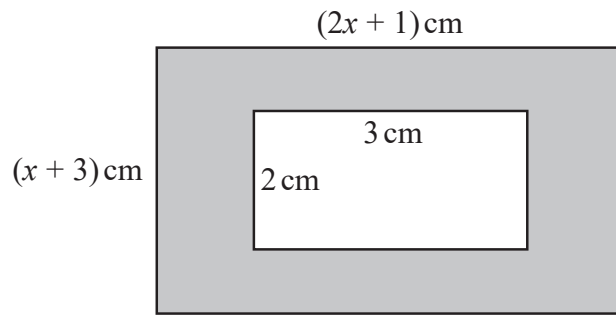

19

Diagram **NOT**
accurately drawn

The diagram shows a rectangular piece of card with length $(2x + 1)$ cm and width $(x + 3)$ cm.

A rectangle of length 3 cm and width 2 cm is cut out of the card.

The area of card that remains, shown shaded in the diagram, is 45 cm^2

(a) Show that $2x^2 + 7x - 48 = 0$

(2)

(b) Find the value of x .

Show your working clearly.

Give your value of x correct to 3 significant figures.

(3)

(Total for Question 19 is 5 marks)

DO NOT WRITE IN THIS AREA

DO NOT WRITE IN THIS AREA

DO NOT WRITE IN THIS AREA



20 Use algebra to show that the recurring decimal $0.2\dot{7}\dot{8} = \frac{46}{165}$

(Total for Question 20 is 2 marks)

21 Express $\frac{x+3}{x-4} - \frac{x+4}{x-3}$ as a single fraction.

Simplify your answer.

(Total for Question 21 is 3 marks)



22 $\frac{5^{n^2}}{5^6} \times \frac{5^{n^2-5n}}{5^3} = 125$ where $n > 0$

Work out the value of n .
Show clear algebraic working.

DO NOT WRITE IN THIS AREA

DO NOT WRITE IN THIS AREA

DO NOT WRITE IN THIS AREA

$n = \dots\dots\dots$

(Total for Question 22 is 5 marks)



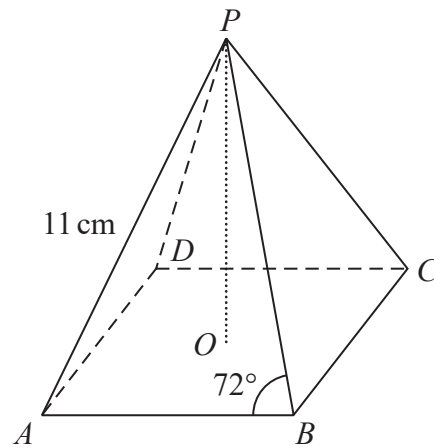

Diagram **NOT**
accurately drawn

The diagram shows a pyramid with a horizontal square base.
The vertex, P , of the pyramid is vertically above the centre, O , of the base.
The triangular faces of the pyramid are congruent isosceles triangles.

In triangle ABP

$PA = PB = 11$ cm and angle $PBA = 72^\circ$

Work out the height, OP , of the pyramid.

Give your answer correct to 3 significant figures.

.....cm

(Total for Question 23 is 4 marks)



Diagram **NOT** accurately drawn

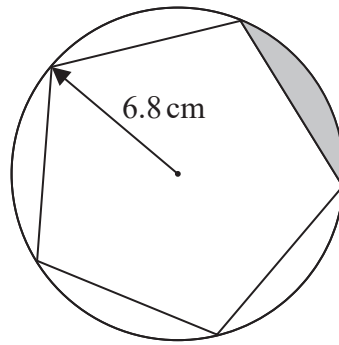

A regular pentagon is drawn inside a circle of radius 6.8 cm.
Each vertex of the pentagon lies on the circle.

Find the perimeter of the region shown shaded in the diagram.
Give your answer correct to 3 significant figures.

DO NOT WRITE IN THIS AREA

DO NOT WRITE IN THIS AREA

DO NOT WRITE IN THIS AREA

.....cm

(Total for Question 24 is 4 marks)



DO NOT WRITE IN THIS AREA

DO NOT WRITE IN THIS AREA

DO NOT WRITE IN THIS AREA

25 A box is in the shape of a cube of side 11.5 cm, correct to 1 decimal place.
A solid spherical ball has radius 5.1 cm, correct to the nearest millimetre.
The ball is placed inside the box and the box is closed.

Work out the upper bound for the volume of the box that is **not** occupied by the ball.
Use $\pi = 3.142$
Show your working clearly.
Give your answer correct to the nearest whole number.

.....cm³

(Total for Question 25 is 4 marks)

TOTAL FOR PAPER IS 100 MARKS



DO NOT WRITE IN THIS AREA

DO NOT WRITE IN THIS AREA

DO NOT WRITE IN THIS AREA

BLANK PAGE

Do NOT write on this page.

